

User Manual

CE48200-W



CHISAGE

www.chisagess.com

Content

Cautions	1
Abbreviation	1
Definition	2
1. General Introduction	3
1.1 Scope and Purpose	3
1.2 Brief Introduction.....	3
1.3 Product Properties	3
1.4 Nameplate.....	4
2. Technical Specification	5
2.1 Battery Specification	5
2.2 BMS Specification.....	6
3. Product Overview.....	9
3.1 Mechanical Structure	9
3.2 Dimension	10
3.3 Electrical Structure.....	10
3.4 Interface Definition.....	11
3.5 State LED Indicate	12
3.6 Capacity LED Indicate	13
3.7 LED Flash Mode	13
3.8 Parallel Setting.....	13
4. Installation and Configuration	13
4.1 Preparations for installation	13
4.2 Installation.....	16
5. Transportation and Storage	18
5.1 Transportation	18
5.2 Storage	18



Cautions

Customers must abide by the operating specifications, and any installation, maintenance, and use of this product must strictly abide by the relevant safety regulations:

- It is forbidden to store or use at high temperatures, and it must be kept from heat sources. These environments above the safe temperature range will significantly decrease this product's performance and life and even cause serious consequences such as burning and explosion.
- It is forbidden to store and use in an environment with high static electricity or electromagnetic radiation. Otherwise, the electronic components in this product will be damaged, which may cause safety hazards
- Do not get wet or even immerse in water. Otherwise, it may cause an internal short circuit, function loss, or abnormal chemical reaction of the product and cause fire, smoke, explosion, etc.
- Suppose you find smoke, heat, discoloration or deformation, or any abnormal phenomenon during use, storage, transportation, and service. In that case, you should immediately contact the professional department to observe further and control the risk.
- Do not dispose of discarded products in fires or hot stoves. Waste batteries should be recovered and recycled by professional institutions or organizations.
- Professional technicians must operate the installation and maintenance of the battery system, and the user must strictly abide by the relevant safety regulations. It is strictly forbidden for non-professionals to install or repair the battery system and abuse it beyond the range.

Abbreviation

ZX	ZHEJIANG CHISAGE NEW ENERGY TECHNOLOGY CO., LTD.
BMS	Battery Management System
BOL	Begin of Life
CAN	Controller Area Network
EOL	End of Life
HV	High Voltage
LV	Low Voltage
OCV	Open Circuit Voltage
SOC	State of Charge

Definition

Battery Cell	The minimum energy storage unit, a basic electrochemical energy storage device, consists of a positive electrode, a negative electrode, an electrolyte, a separator, and a casing, also known as a battery cell.
Battery Module (Battery PACK)	A power supply system composed of several battery modules, circuit equipment (protection circuit, cell management system, electrical and communication interfaces), thermal management devices, etc., is used to provide energy for electrical devices.
Nominal Voltage	Indicates or identifies the appropriate voltage approximation for the cell or pack.
Capacity	The amount of electricity that can be provided by a battery cell that is fully charged under specified conditions. Usually expressed in Ah.
Energy Capacity	The energy can be provided by a fully charged battery cell or pack under specified conditions. Usually expressed in Wh or kWh.
Nominal Capacity	At the beginning of life (BOL), the minimum capacity that a fully charged cell can be provided under specified conditions is when it is discharged at a rate of 1C (C-rate).
Unit	<p>“V” (Volt): Electrical current unit;</p> <p>“A” (Ampere): Electrical current unit;</p> <p>“Ah” (Ampere-Hour): Electrical charge unit;</p> <p>“Wh” (Watt-Hour): Electrical energy unit;</p> <p>“Ω” (Ohm): Resistance unit;</p> <p>“°C” (Celsius degree): Temperature unit;</p> <p>“mm”(millimeter): Length unit;</p> <p>“s” (second): Time unit;</p> <p>“kg” (kilogram): Weight unit;</p> <p>“Hz” (Hertz): Frequency unit.</p>

1. General Introduction

1.1 Scope and Purpose

This product user manual only applies to the rechargeable lithium-ion battery products CE48200-W designed by Zhejiang Chisage New Energy Technology co., Ltd.

The user manual aims to introduce the CE48200-W product information and installation, operation, and maintenance guidelines. Include the battery pack and BMS specification, internal and external structure, LED indication, battery set, battery system diagram, and other cautions. The manual cannot include complete information about the BESS system.

The interpretation right of this specification belongs to Zhejiang Chisage New Energy Technology Co., Ltd.

1.2 Brief Introduction

CE48200-W is designed according to market requirements to meet the client's wall-mounted application requirement. In operation with the hybrid or off-grid inverter, you can charge the battery when PV or grid is available and discharge the battery when you need the backup power supply.

The battery can be paralleled to build a high-capacity hybrid system to satisfy the long-time energy storage demand.

1.3 Product Properties

CE48200-W product's anode materials are lithium iron phosphate, and battery cells are managed effectively by BMS with better performance, the systems features as below:

- Anode materials are lithium iron phosphate (LiFePO₄), safer with a longer life span.
- Flexible configurations allow parallel multi-battery for longer standby time.
- Self-ventilation with lower system noise.
- With a wide range of temperatures for the working environment, 0°C~+50°C, circulation span, and discharging performance are well under high temperatures.
- Carries battery management system with better performance and possesses protection functions like over-discharge, over-charge, over-current, and abnormal temperature.
- Self-management on charging and discharging, single core balancing function.
- Support the most mainstream CAN and RS485 protocol

1.4 Nameplate















Model: CE48200-W	
Description:	Lithium Battery
Total Energy:	10.24 kWh
Nominal Capacity:	200 AH
Voltage Range:	40 ~ 58.4Vd.c
Nominal Voltage:	51.2Vd.c
Max.Charge Voltage:	58.4V±0.5Vd.c
Constant Current:	100 A
Operating Temperature:	-20°C ~ 55°C
Protective Class:	1
Ingress Protection:	IP65
Weight(Kg):	≈114
Dimensions (mm):	970x520x196.5
Company Name: ZHEJIANG CHISAGE NEW ENERGY TECHNOLOGY CO.,LTD Add: NO.1828 FUQING SOUTH RD., PANHUO ST., YINZHOU ,NINGBO, ZHEJIANG, 315100 CHINA Tel: +86 150 5749 1826 Email: info@chisagess.com Website: www.chisagess.com	
            	
Made in China	

Fig. 1-1 CE48200-W nameplate

2. Technical Specification

2.1 Battery Specification

No.	Item	Specification	Remark
1	Battery Cell Model	LFP100Ah	Lithium Iron Phosphate
2	Battery Module	2P16S	
3	Nominal Capacity	200Ah	
4	Nominal Voltage	51.2V	Singe cell: 3.2V
5	Operation Voltage Range	40V~58.4V	
6	Nominal Energy	10.24kWh	
7	Operation Voltage	Charge Temperature : 0°C~55°C; Discharge Temperature: -20°C~55°C.	
8	Storage Temperature	-20°C~50°C	25°C is necessary for more than three-month of storage
9	Working Humidity	20~95%RH	
10	Standard Charge Current	0.5C	
11	Maximum Continuous Charge Current	0.5C	
12	Standard Discharge Current	0.5C	
13	Maximum Continuous Discharge Current	0.5C	(1C, 25±2°C)
14	PACK Weight	About 114Kg	
15	Dimension	Length: 970 (±2) mm Depth: 520 (±2) mm Height: 196.5 (±2) mm	

2.2 BMS Specification

BMS Protection Parameter		
Function	Item	Protection Parameter
Single Cell Alarm	Overvoltage alarm	3.6±0.02V
	Overvoltage recovery	3.5±0.02V
	Undervoltage alarm	2.7±0.02V
	Undervoltage recovery	3.0±0.02V
Single Cell Protection	Overvoltage alarm	3.65±0.02V
	Overvoltage recovery	3.6±0.02V
	Undervoltage alarm	2.5±0.02V
	Undervoltage delay	3000ms
	Undervoltage recovery	2.7±0.02V
General Voltage Alarm	Overvoltage alarm	57.6±0.05V
	Overvoltage delay	3000ms
	Overvoltage recovery	56±0.05V
	Undervoltage alarm	43.2±0.05V
	Undervoltage delay	3000ms
	Undervoltage recovery	46.4±0.05V
General Voltage Protection	Overvoltage alarm	58.4±0.05V
	Overvoltage delay	3000ms
	Overvoltage recovery	57.6±0.05V
	Undervoltage alarm	40±0.05V
	Undervoltage delay	3000ms
	Undervoltage recovery	43.2±0.05V
Cell temperature charging forbids alarm	High temperature charging alarm	47±2°C
	High temperature charging alarm recovery	45±2°C
	Low temperature charging alarm	5±2°C

	Low temperature charging alarm recovery	$8\pm 2^{\circ}\text{C}$
Cell temperature charging forbids protection	High temperature charging protection	$50\pm 2^{\circ}\text{C}$
	High temperature charging protection recovery	$48\pm 2^{\circ}\text{C}$
	Low temperature charging protection	$0\pm 2^{\circ}\text{C}$
	Low temperature charging protection recovery	$5\pm 2^{\circ}\text{C}$
Cell temperature discharging forbids alarm	High temperature charging alarm	$52\pm 2^{\circ}\text{C}$
	High temperature discharging alarm recovery	$50\pm 2^{\circ}\text{C}$
	Low temperature discharging alarm	$-15\pm 2^{\circ}\text{C}$
	Low temperature discharging alarm recovery	$-10\pm 2^{\circ}\text{C}$
Cell temperature discharging forbids protection	High temperature discharging protection	$55\pm 2^{\circ}\text{C}$
	High temperature discharging protection recovery	$52\pm 2^{\circ}\text{C}$
	Low temperature discharging protection	$-20\pm 2^{\circ}\text{C}$
	Low temperature discharging protection recovery	$-15\pm 2^{\circ}\text{C}$
Charge overcurrent alarm	Charge overcurrent alarm	$105\pm 2\text{A}$
	Charge overcurrent alarm recovery	$100\text{A}\pm 2\text{A}$
Charge overcurrent protection	Charge overcurrent protection	$110\pm 2\text{A}$
	Charge overcurrent protection recovery	$100\pm 2\text{A}$
Discharge overcurrent alarm	Discharge overcurrent alarm	$105\pm 2\text{A}$

	Discharge overcurrent alarm recovery	100A±2A
Discharge overcurrent protection	Discharge overcurrent protection	110±2A
	Discharge overcurrent protection recovery	100±2A
SOC low alarm	SOC low alarm	15%
	SOC low alarm recovery	20%
Short Protection	Short circuit protection current	300±100A
	Short circuit protection released	<ol style="list-style-type: none"> 1. Detect valid current data. 2. Re-check every 1min, and lock after three consecutive times

3. Product Overview

3.1 Mechanical Structure

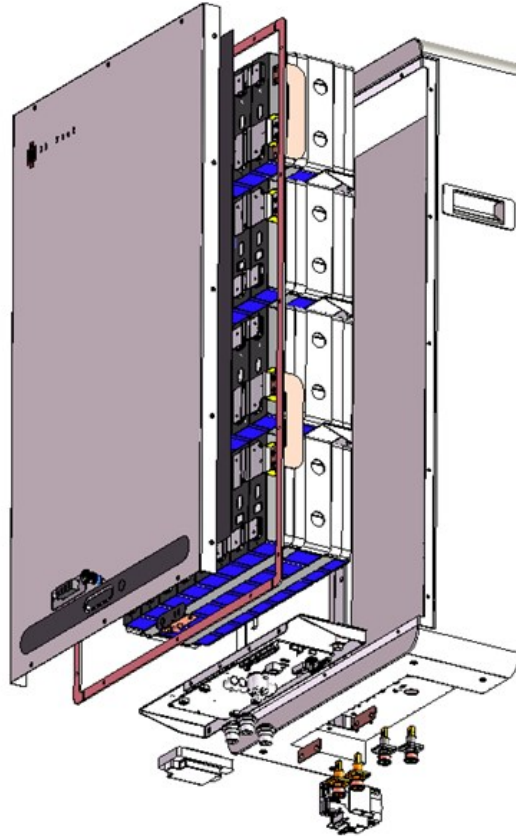

Fig. 3-1 CE48200-W PACK mechanical structure 1

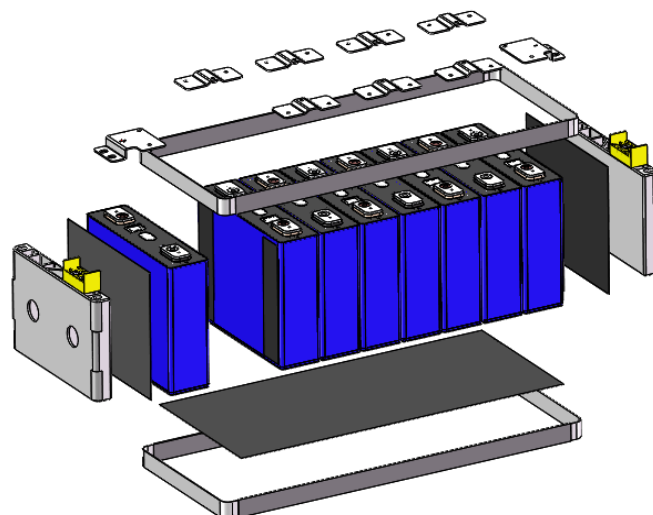

Fig. 3-2 CE48200-W PACK mechanical structure 2

3.2 Dimension

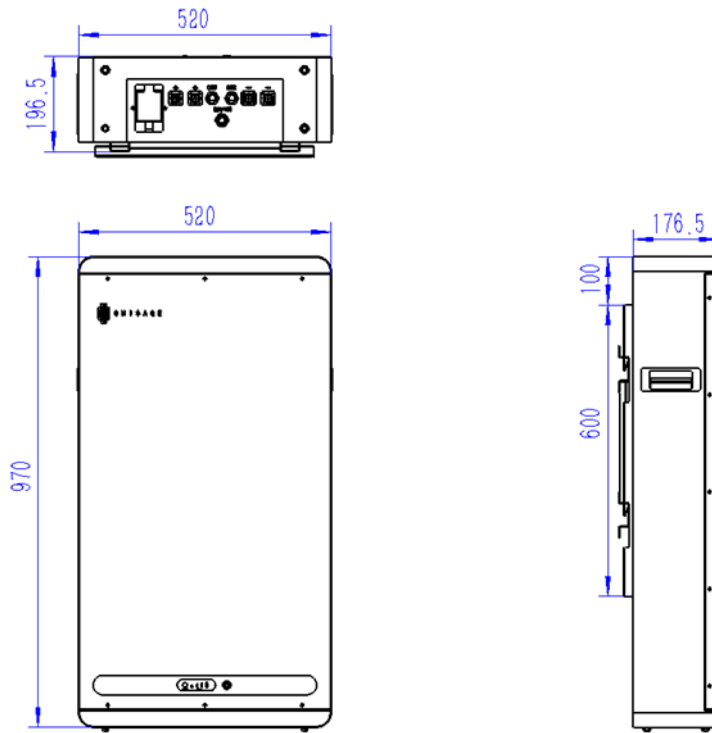

Fig. 3-3 CE48200-W PACK dimension drawing

3.3 Electrical Structure

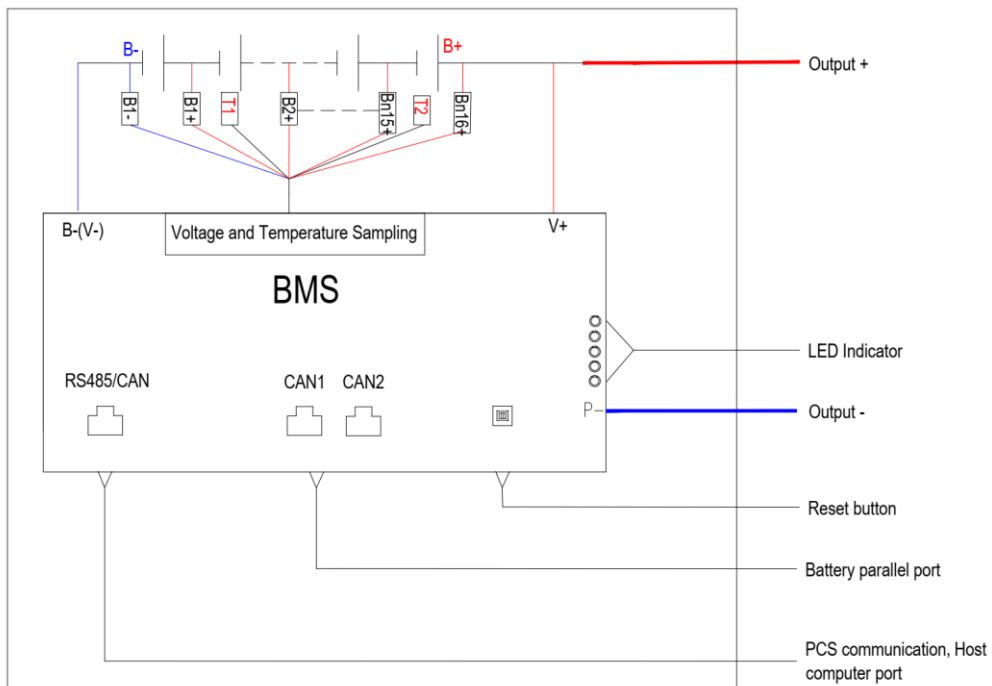

Fig. 3-4 CE48200-W PACK electrical structure

3.4 Interface Definition

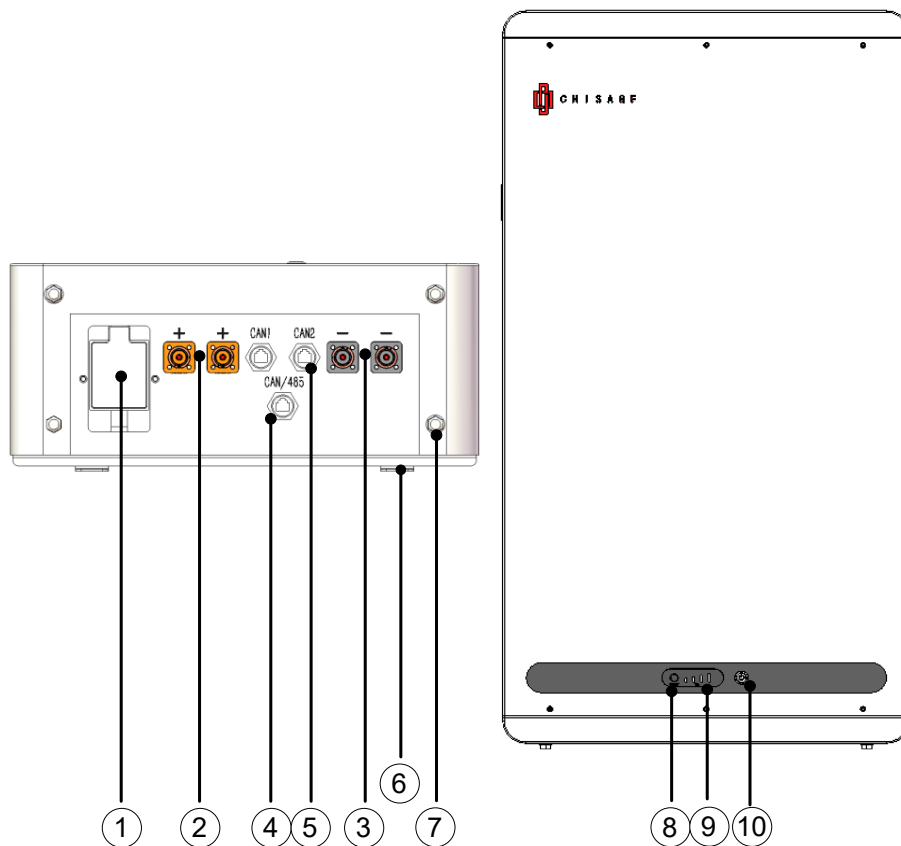

Fig. 3-5 CE48200-W PACK interface

No.	Interface	Legend	Description	Remark
1	DC breaker	/	125A	
2	Battery power +		Battery positive terminal	125A
3	Battery power -		Battery negative terminal	125A
4	Host computer & BMS communication port		EMS/CAN/RS485: PIN 1, 8: 485B PIN 2, 7: 485A PIN 3, 6: GND PIN 4: CANH PIN 5: CANL	The network cable adopts Category 5 double-shielded twisted pair cable, shielded crystal head RJ45 (8P8C), and the actual product shall prevail.
5	Parallel communication port		CAN1: PIN 4: CANH PIN 5: CANL	The network cable adopts Category 5 double-shielded twisted

			PIN 1, 2, 3, 6, 7, 8: NC	pair cable, shielded crystal head RJ45 (8P8C), and the actual product shall prevail.
6	Battery back bracket	/	/	Default for wall mounted application
7	Floor mount feet installation hole	/	/	Floor mount optional
8	Reset button	/	After the battery reaches the limit protection, it needs to be restarted by the Reset button.	
9	Capacity LED	/	Please check clause 3.6	
10	ON/OFF Button	/	/	/

3.5 State LED Indicate

System State	Running State	Capacity LED				Remark
		●	●	●	●	
Battery Off	Sleep	All OFF				
Battery Standby	Normal	Check Capacity LED				
	Alarm					
Charge	Normal	Check Capacity LED				
	Alarm	Check Capacity LED				Overcharge protection ALM doesn't flash
	Over Voltage Protection	All ON				
	Temperature, overcurrent, short circuit, fail protection	All OFF				
Discharge	Normal	Check Capacity LED				
	Alarm	Check Capacity LED				

	Low Voltage Protection	All OFF	
	Temperature, overcurrent, short circuit, fail protection	All OFF	

3.6 Capacity LED Indicate

State	Charge				Discharge			
	L4●	L3●	L2●	L1●	L4●	L3●	L2●	L1●
Capacity LED ●								
0~25%	OFF	OFF	OFF	Flash 2	OFF	OFF	OFF	ON
25%~50%	OFF	OFF	Flash 2	ON	OFF	OFF	ON	ON
50%~75%	OFF	Flash 2	ON	ON	OFF	ON	ON	ON
75%~100%	Flash 2	ON	ON	ON	ON	ON	ON	ON

3.7 LED Flash Mode

Mode	ON	OFF
Flash 1	0.25S	3.75S
Flash 2	0.5S	0.5S
Flash 3	0.5S	1.5S
Flash 4	0.35S	0.3S

3.8 Parallel Setting

The lowest SN machine will be set as master inverter automatically.

4. Installation and Configuration

4.1 Preparations for installation

This system can only install by personnel who have been trained in the power supply system and have sufficient knowledge of the power system.

The local safety regulations listed below should always be followed during the installation.

- All circuits connected to this power system with an external voltage of less than 48V must meet the SELV requirements defined in the IEC60950 standard.

- If operating within the power system cabinet, make sure the power system is not charged. Battery devices should also be switched off.
- Distribution cable wiring should be reasonable and has protective measures to avoid touching these cables during the operation of power equipment.
- When installing the battery system, must wear the protective items below:



The isolation gloves



Safety goggles



Safety shoes

4.1.1 Environmental requirements

- Working temperature: 0°C~+50°C
 - 1) Charging temperature range is 0°C ~+45°C;
 - 2) Discharging temperature range is -20°C ~+50°C;
- Relative humidity: 20% ~ 95%RH (No condensed water);
- Operating environment: Indoor or outdoor installation, sites avoid the sun, no corrosive gas. And the following conditions are met:
 - 1) Installation location should be away from the sea to avoid brine and high humidity environment;
 - 2) The ground is flat and level;
 - 3) There is no flammable explosive near to the installation places. The optimal ambient temperature is 15°C ~ 30°C;

4.1.2 Tools

The following tools and meters that may be used for installation



Screwdriver (word, cross)



Inclined pliers



Wrench



Needle nose pliers



Wire stripper



Clamp meter



Insulating tape



Multimeters







4.1.3 Technical Preparation

Devices connected directly to the battery can be user equipment, power supplies, or other power supplies.

- Confirm whether the user equipment, the PV equipment or other power supply equipment has the DC standby interface, and measure whether the output voltage of the standby interface meets the requirements of the voltage range;
- Verify that the maximum discharge current capacity of the user equipment, the PV equipment or other power supplies, the DC standby interface, and the maximum discharge current shall be greater than the maximum charging current of the products;
- If the user equipment DC prepared interface maximum discharge capacity is less than the maximum charging current product, the user interface should have the power equipment of DC limiting function, prioritizing the normal work of user equipment.
- Firefighting equipment, such as portable dry powder fire extinguishers, should be provided near the equipment.
- An automatic fire fighting system shall be provided for the case where necessary. No flammable, explosive or other dangerous articles are placed beside the battery.

4.1.4 Open the Package and Inspection

- When the equipment arrives at the installation site, loading and unloading should be carried out according to the rules and regulations, so as to prevent from being exposed to sun and rain.
- Before unpacking, the total number of packages shall be indicated according to the shipping list attached to each package, and the case shall be checked for good condition
- In the process of unpacking, handle with care and protect the surface coating of the object.
- Open the package, the professional installation person should read the technical documents, verify the list, according to the configuration table and packing list, and ensure objects are complete and intact. If the internal packaging is damaged, it must be inspected and recorded in detail.

 <p>Battery x 1 pcs</p>	 <p>User Manual x 1 pcs</p>	 <p>Wall mounted bracket x 1 pcs</p>
 <p>M6*50 expansion bolt x 8 pcs</p>	 <p>Battery cable (Optional)</p>	 <p>Floor mounted feet (Optional)</p>

4.2 Installation

4.2.1 Installation Step

- **Step 1:** Draw the screw hole positions on the wall;
- **Step 2:** Fixing the expansion bolt M6 into the hole on the wall, and fix the support bracket and battery wall back bracket on the wall with M6 bolts;
- **Step 3:** Fixing the battery back bracket on the battery by M8 screw;
- **Step 4:** Connect the battery power cable to the inverter;
- **Step 5:** Carry of hoist the battery to the installed battery on wall mounted bracket;
- **Step 6:** Connect the communication cable to the inverter;
- **Step 7:** Inverter parameter setting;
- **Step 8:** Close the battery breaker;
- **Step 9:** Turn on the battery and check the battery condition.

4.2.2 Connection Diagram

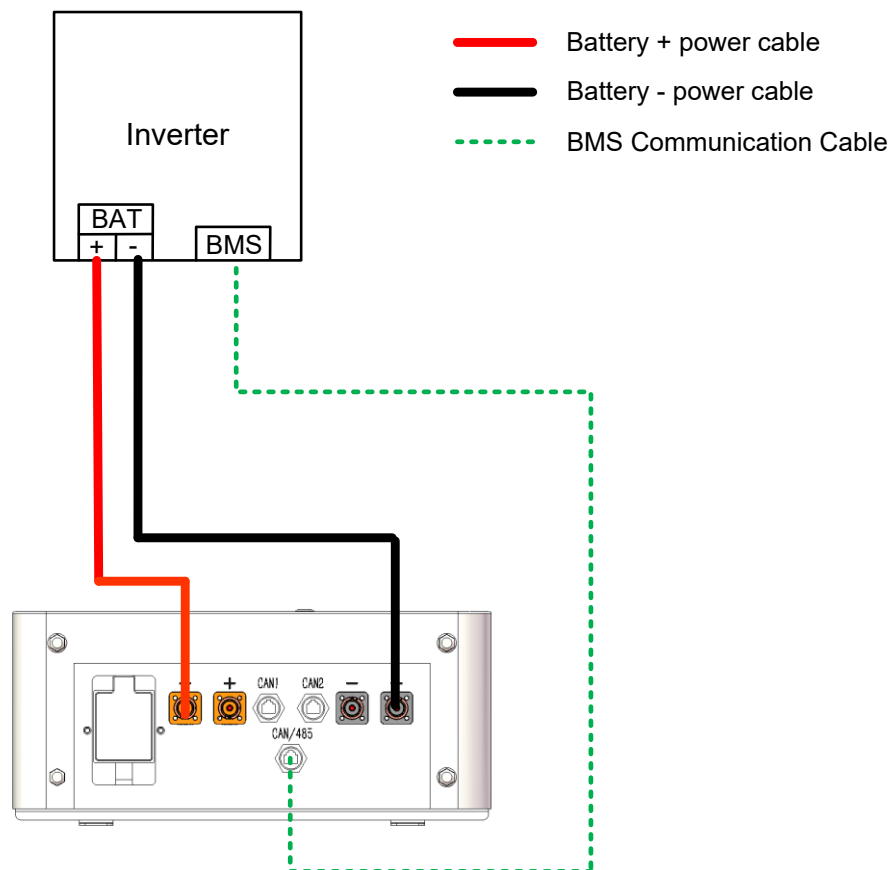

Fig. 4-1 Single CE48200-W PACK + single inverter diagram

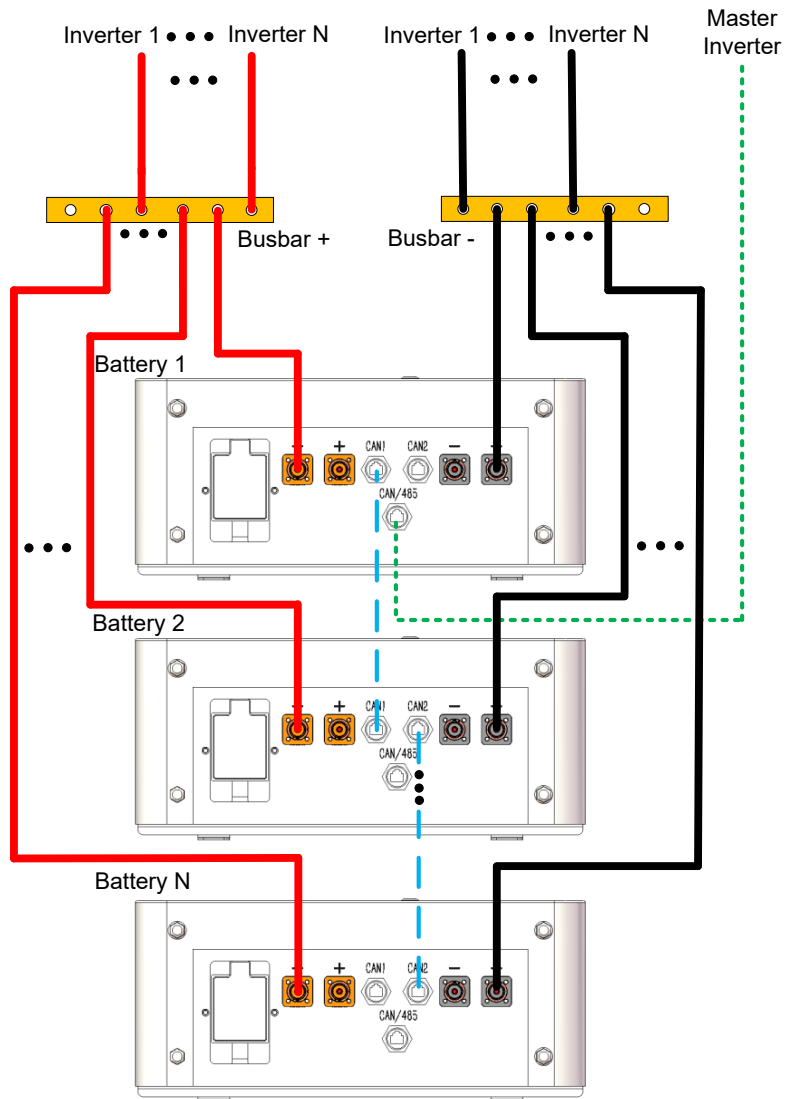

Fig. 4-2 Multi CE48200-W PACK + multi inverter diagram

5. Transportation and Storage

5.1 Transportation

During transportation, it should be protected from violent vibration, shock, sun exposure, and rain and must not be inverted to ensure that no short circuit occurs. In the process of loading and unloading, it should be handled with care to prevent falling, rolling, heavy pressure, and inversion.

5.2 Storage

Product storage requirements are as follows:

- When the battery PACK is long time stored, the battery should be charged to 60% SOC.
- Electrical box products should be stored in a dry and ventilated environment with a temperature not exceeding 50°C and relative humidity less than 80%. For inflammable and explosive items, avoid places with a lot of dust and metal powder, and avoid contact with acid or other corrosive gases;
- The storage location of electric box products should be protected from rain, moisture, and sun protection.
- Storage temperature: The storage temperature range is -10°C~35°C. If it is expected to be stored for more than 1 month and not more than 6 months, you should do a charge and discharge in advance and adjust the SOC to 20% to 50%. Zhejiang Chisage New Energy Technology Co., Ltd. will not be responsible for the loss of capacity or other losses if the storage SOC exceeds the range of 20-50% or the storage for more than 6 months without charge and discharge maintenance.



CHISAGE ESS



ZHEJIANG CHISAGE NEW ENERGY TECHNOLOGY CO.,LTD.

Tel: +86 150 5749 1826

E-mail: info@chisagess.com

Web: www.chisagess.com

Add: NO. 1828, FUQING SOUTH RD., PANHUO ST., YINZHOU DISTRICT, NINGBO, ZHEJIANG, 315000 CHINA

V1.0
